

aiwa

**STEREO RECEIVER
RECEPTOR ESTEREO
AMPLI-TUNER STEREO**

AV-D58

**OPERATING INSTRUCTIONS
MANUAL DE INSTRUCCIONES
MODE D'EMPLOI**

En (English)

E (Español)

F (Français)

For assistance and information

call toll free 1-800-BUY-AIWA

(United States and Puerto Rico)

8B-AR3-903-01
010125ACK-U-M

U

DIGITAL
dts[®]
SURROUND

WARNING

TO REDUCE THE RISK OF FIRE OR ELECTRIC SHOCK, DO NOT EXPOSE THIS APPLIANCE TO RAIN OR MOISTURE.



Explanation of Graphical Symbols:



The lightning flash with arrowhead symbol, within an equilateral triangle, is intended to alert the user to the presence of uninsulated "dangerous voltage" within the product's enclosure that may be of sufficient magnitude to constitute a risk of electric shock to persons.



The exclamation point within an equilateral triangle is intended to alert the user to the presence of important operating and maintenance (servicing) instructions in the literature accompanying the appliance.

Owner's record

For your convenience, record the model number and serial number (you will find them on the rear of your unit) in the space provided below. Please refer to them when you contact your Aiwa dealer in case of difficulty.

Model No.	Serial No. (Lot No.)
AV-D58	

PRECAUTIONS

Read the Operating Instructions carefully and completely before operating the unit. Be sure to keep the Operating Instructions for future reference. All warnings and cautions in the Operating Instructions and on the unit should be strictly followed, as well as the safety suggestions below.

Installation

- 1 Water and moisture** — Do not use this unit near water, such as near a bathtub, washbowl, swimming pool, or the like.
- 2 Heat** — Do not use this unit near heat sources, including heating vents, stoves, or other appliances that generate heat. It also should not be placed in temperatures less than 5°C (41°F) or higher than 35°C (95°F).
- 3 Mounting surface** — Place the unit on a flat, even surface.
- 4 Ventilation** — The unit should be situated with adequate space around it so that proper heat ventilation is assured. Allow 10 cm (4 in.) clearance from the rear and the top of the unit, and 5 cm (2 in.) from each side.
 - Do not place the unit on a bed, rug, or similar surface that may block the ventilation openings.
 - Do not install the unit in a bookcase, cabinet, or airtight rack where ventilation may be impeded.
- 5 Objects and liquid entry** — Take care that objects or liquids do not get inside the unit through the ventilation openings.
- 6 Carts and stands** — When placed or mounted on a stand or cart, the unit should be moved with care. Quick stops, excessive force, and uneven surfaces may cause the unit or cart to overturn or fall.
 
- 7 Wall or ceiling mounting** — The unit should not be mounted on a wall or ceiling, unless specified in the Operating Instructions.

Electric Power

- 1 Power sources** — Connect this unit only to power sources specified in the Operating Instructions, and as marked on the unit.
- 2 Polarization** — As a safety feature, some units are equipped with polarized AC power plugs which can only be inserted one way into a power outlet. If it is difficult or impossible to insert the AC power plug into an outlet, turn the plug over and try again. If it is not still inserted easily into the outlet, please call a qualified service technician to service or replace the outlet. To avoid defeating the safety feature of the polarized plug, do not force it into a power outlet.
- 3 AC power cord**
 - When disconnecting the AC power cord, pull it out by the AC power plug. Do not pull the cord itself.
 - Never handle the AC power plug with wet hands, as this could result in fire or shock.
 - Power cords should be firmly secured to avoid being severely bent, pinched, or walked upon. Pay particular attention to the cord from the unit to the power socket.
 - Avoid overloading AC outlets and extension cords beyond their capacity, as this could result in fire or shock.
- 4 Extension cord** — To help prevent electric shock, do not use a polarized AC power plug with an extension cord, receptacle, or other outlet unless the polarized plug can be completely inserted to prevent exposure of the blades of the plug.
- 5 When not in use** — Unplug the AC power cord from the AC power outlet if the unit will not be used for several months or more. When the cord is plugged in, a small amount of current continues to flow to the unit, even when the power is turned off.

Outdoor Antenna

- 1 Power lines** — When connecting an outdoor antenna, make sure it is located away from power lines.
- 2 Outdoor antenna grounding** — Be sure the antenna system is properly grounded to provide protection against unexpected voltage surges or static electricity build-up. Article 810 of the National Electrical Code, ANSI/NFPA70, provides information on proper grounding of the mast, supporting structure, and the lead-in wire to the antenna discharge unit, as well as the size of the grounding unit, connection to grounding terminals, and requirements for grounding terminals themselves.

Antenna Grounding According to the National Electrical Code

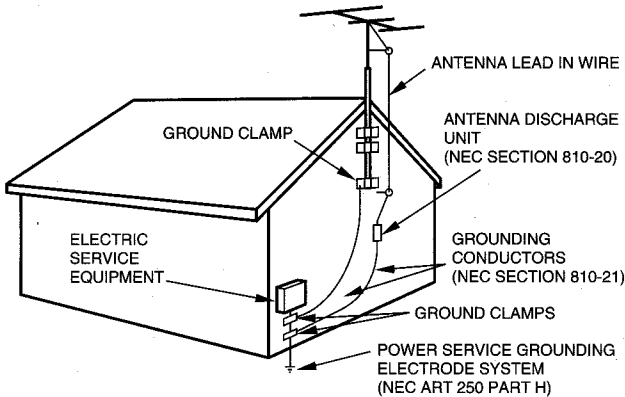

NEC-NATIONAL ELECTRICAL CODE

Maintenance

Clean the unit only as recommended in the Operating Instructions.

Damage Requiring Service

Have the unit serviced by a qualified service technician if:

- The AC power cord or plug has been damaged
- Foreign objects or liquid have gotten inside the unit
- The unit has been exposed to rain or water
- The unit does not seem to operate normally
- The unit exhibits a marked change in performance
- The unit has been dropped, or the cabinet has been damaged

DO NOT ATTEMPT TO SERVICE THE UNIT YOURSELF.

TABLE OF CONTENTS

PRECAUTIONS	2
PREPARATIONS	
CONNECTIONS	4
BEFORE OPERATION	8
SETTING THE CLOCK	9
SOUND	
CUSTOM AUDIO ADJUSTMENT	10
DSP SURROUND	11
BASIC OPERATIONS	
SELECTION OF AUDIO/VIDEO SOURCE	12
RECORDING AN AUDIO SOURCE	13
RADIO RECEPTION	
MANUAL TUNING	14
PRESETTING STATIONS	15
DOLBY SURROUND AND DTS SURROUND	
SELECTING DOLBY SURROUND	16
ADJUSTING SPEAKER LEVEL BALANCE	17
ADJUSTING LFE AND DYNAMIC RANGE	19
SELECTING DTS SURROUND	20
TIMER	
SETTING THE SLEEP TIMER	21
GENERAL	
SPECIFICATIONS	22
CARE AND MAINTENANCE	23
TROUBLESHOOTING GUIDE	23
PARTS INDEX	23

En

Check your accessories

Remote control

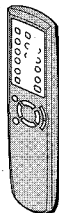

FM antenna

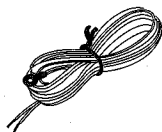

AM antenna

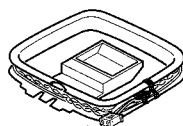

Operating Instructions, etc.

Dynamic Integrated Neo Amplifier

is a brand-new amplifier system where clear mid-to-high range frequency sound, as well as rich low frequency sound, can be reproduced and listeners can enjoy the close-to-original sound with less distortion at either high or low volume levels.



As an ENERGY STAR® Partner, AIWA has determined that this product meets the ENERGY STAR® guidelines for energy efficiency.

CONNECTIONS

Before connecting the AC cord

The rated voltage of your unit shown on the rear panel is 120 V AC. Check that the rated voltage matches your local voltage.

IMPORTANT

Connect the speakers, antennas, and all other external equipment first. Then connect the AC cord at the end.

CONNECTING EQUIPMENT

Jacks and plugs of the connecting cord are color-coded as follows:
 Red jacks and plugs : For the right channel of audio signals
 White jacks and plugs: For the left channel of audio signals
 Yellow jacks and plugs: For video signals

NOTE

Insert the plugs fully into the jacks. Loose connections may produce a humming sound or other noise interference.

- *1 Be sure to connect the VIDEO OUT terminal of a DVD player directly to a TV set, not through this unit. Otherwise, the picture noise may appear when playing copy protected DVDs.
- *2 Input sound through the digital in terminals (VIDEO 2 COAXIAL IN, VIDEO 1 OPTICAL IN) cannot be recorded. When recording the sound from the DVD, CD, MD or LD player, connect the analog AUDIO OUT terminals of the player to the corresponding AUDIO IN terminals of the receiver.
- *3 When connecting a monaural video, use a stereo-mono connecting cord (not supplied).
- *4 When connecting an LD player equipped with the AC-3 RF OUT terminal, use an RF demodulator unit. Also connect the analog AUDIO OUT terminals of the LD player to the receiver to play all the sources. For further information, refer to the instructions of the LD player.

DVD or Video 1²³/MD player

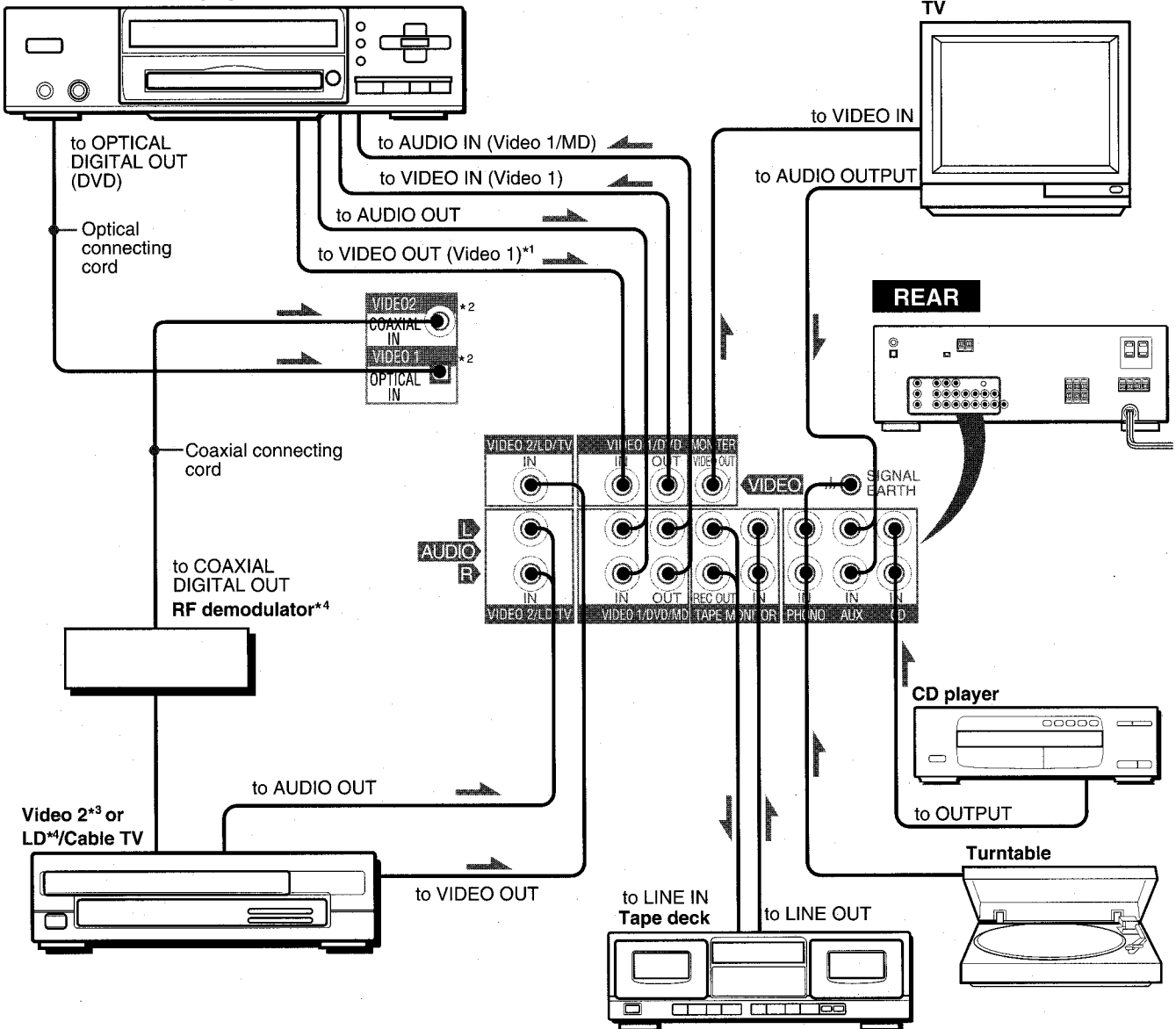

①, ② and ③ in the illustration correspond to the following details.

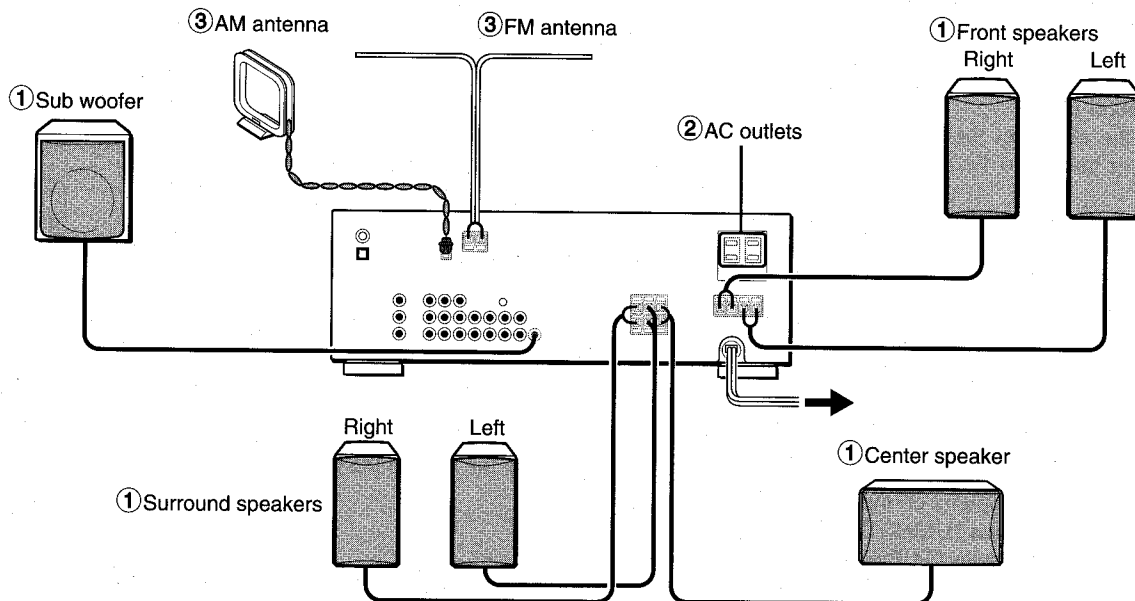

CONNECTING SPEAKERS①

Speaker terminals

Connect front speakers, a center speaker, surround speakers and a sub woofer to the corresponding speaker terminals on the unit:

- the front speaker cords to the FRONT SPEAKERS terminals
- the center speaker cord to the CENTER SPEAKER terminals
- the surround speaker cords to the SURROUND SPEAKERS terminals.
- for more powerful bass, the sub woofer (with a built-in amplifier) cord to the SUB WOOFER jack

When connecting the sub woofer, be sure to select the "SUBW ON" (sub woofer on) mode (see page 6).

Speaker impedance

For all speakers, use speakers of 8 ohms or more.

Connecting + to +, - to - terminals

To get the proper sound effect, the speaker terminals on the unit and the speaker should be connected with proper polarity; the + terminal on the unit should be connected to the + terminal on the speaker (and - to -).

NOTE

- Be sure to connect the speaker cords correctly as shown in the illustration on the right column. Improper connections can cause short circuits in the SPEAKER(S) terminals.
- Do not leave objects generating magnetism near the speakers.

Front speakers

Lift up the terminal flap, insert the speaker cord lead into the terminal slot, then close the flap. Check that the cord is connected securely.

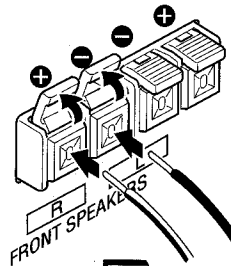

Surround speakers

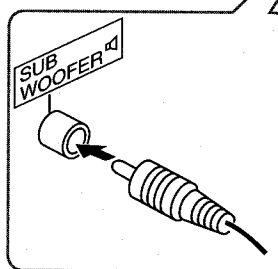
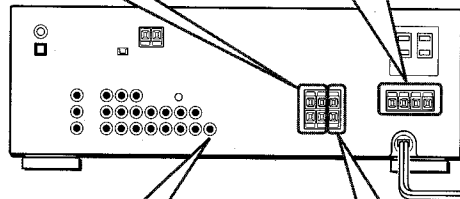
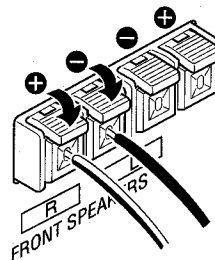
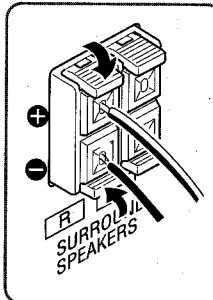

Sub woofer

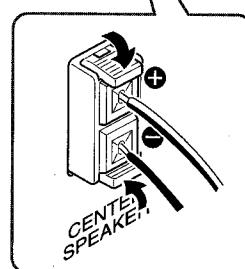

Center speaker

En

POSITIONING THE SPEAKERS

Position the speakers to make the most of Dolby, DTS or DSP surround effect.

Front speakers (L/R)

Center speaker (C)

Position in the center of the two front speakers. In addition, position on or below the TV set, if connecting a TV set to the unit.

Surround speakers (LS/RS)

Place the surround speakers directly to the side of or slightly behind the listening area. Align them horizontally, about 1 meter (3.2 feet) above ear height.

Sub woofer (SW)

Place the sub woofer in any place between the two front speakers.

When connecting a sub woofer

Select "SUBW ON" mode.

1. Press MANUAL SELECT on the remote control once so that "SUBW OFF" appears on the display.
2. Within 4 seconds, press TUNING DOWN ∇ or turn MULTI JOG to the left to display "SUBW ON."

If a sub woofer is not connected, be sure to select "SUBW OFF"

Display "SUBW ON" in step 1 and press TUNING UP \wedge or turn MULTI JOG to the right in step 2.

NOTE

Sound from the surround speakers or center speaker depends on the setting of Dolby, DTS or DSP surround.

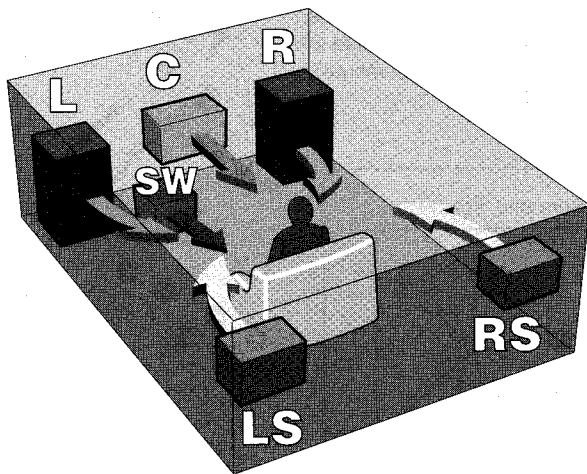

USING AC OUTLETS ON THE UNIT ②

The unit is equipped with AC outlets. You can use them once the unit is connected to an AC outlet on a wall.

Do not connect equipment beyond their capacity (120 W, 1 A MAX. and TOTAL)

CONNECTING THE SUPPLIED ANTENNAS ③

Connect the FM antenna to the FM 75 Ω terminals and the AM antenna to the AM LOOP jack.

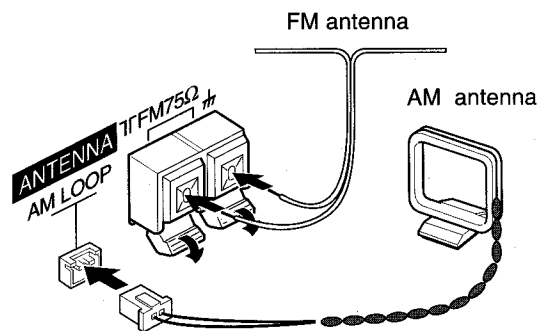

To stand the AM loop antenna on a surface

Fix the claw to the slot as shown in the illustration.

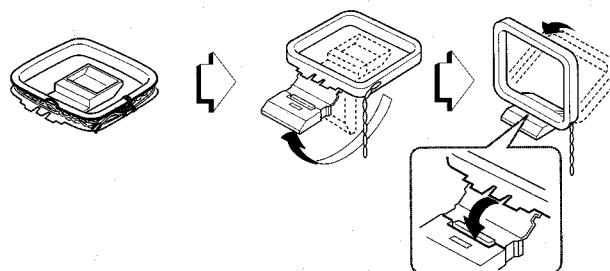

To position the antennas

FM feeder antenna:

Extend this antenna horizontally in a T shape and fix its ends to the wall.

AM loop antenna:

Position for the best reception.

NOTE

- Do not bring the FM antenna near metal objects or curtain rails.
- Do not bring the AM antenna near other external equipment, the unit itself, the AC power cord or speaker cords, as noise will be picked up.
- Do not unwind the AM loop antenna wire.

CONNECTING AN OUTDOOR ANTENNA

For better FM reception, use of an outdoor antenna is recommended. Connect the outdoor antenna to the FM 75 Ω terminals.

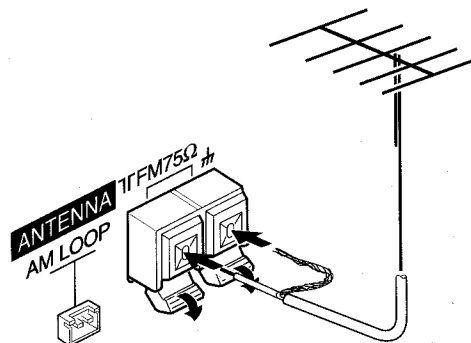

ABOUT THE REMOTE CONTROL

Inserting batteries

Detach the battery cover on the rear of the remote control and insert two R6 (size AA) batteries.

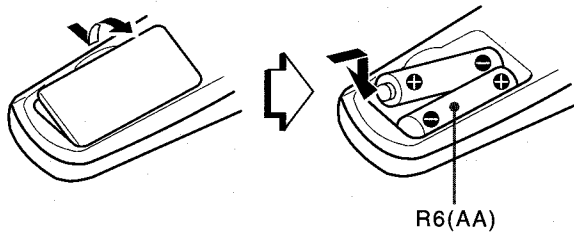

When to replace the batteries

The maximum operational distance between the remote control and the sensor on the unit should be approximately 5 meters (16 feet). When this distance decreases, replace the batteries with new ones.

Using the remote control

The instructions in this manual refer mainly to the buttons on the main unit. In principle the buttons on the remote control and the main unit with identical or similar indications have the same functions.

Some buttons have two functions.

- To use the function indicated on the button, or on the plate in black, simply press the button.
- To use the function indicated on the plate in green, press the button while pressing SHIFT.

Important

ENTER on the remote control does not substitute for ENTER on the main unit. This button is for operating the DVD player only (see right column.)

To select the function (audio source) with the remote control

Press FUNCTION repeatedly. The function changes cyclically.

NOTE

- If the unit is not going to be used for an extended period of time, remove the batteries to prevent possible electrolyte leakage.
- The remote control may not operate correctly when:
 - The line of sight between the remote control and the remote sensor in the display window is exposed to intense light, such as direct sunlight.
 - Other remote controls are used nearby (those of a television, etc.)

Operating AIWA CD or DVD players with the remote control

You can control the basic functions of AIWA CD or DVD players with the remote control. In principle, the buttons described below have the same function as those on the DVD or CD players. For more details, refer to the operating instructions of the player.

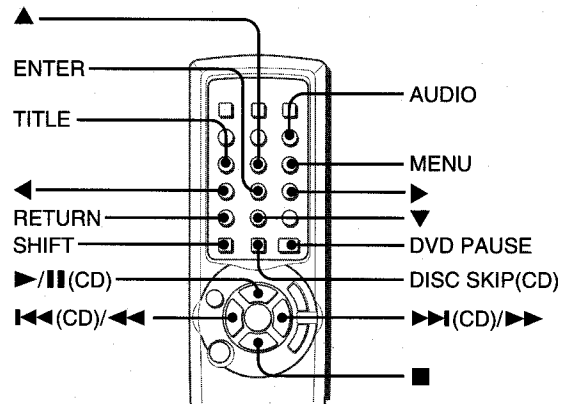

Operating CD players

Press the following button.

- ▶/|| (CD) - Starts or pauses playback.
- <<<, >>> - Searches a track. Hold the button down.
- <<< (CD), >>> (CD) - Skips a track. Press the button repeatedly.
- - Stops playback.
- DISC SKIP (CD) - Skips a disc in the CD changer.

Operating DVD players

Press the following button while pressing SHIFT.

- ▶ - Starts playback.
- <<<, >>> - Searches a track.
- - Stops playback.
- ▲, ▼, ◀, ▶ (up, down, left or right) - Moves the cursor to select a program etc.
- AUDIO - Changes an audio track (language etc.)
- ENTER - Enters the selected program etc.
- TITLE or MENU - Enters the title or menu screen.
- RETURN - Returns to the previous mode etc.
- DVD PAUSE - Pauses the playback of a DVD.

NOTE

There are some AIWA COMPACT DISC PLAYERS for which some of the functions of the remote control do not work.

BEFORE OPERATION

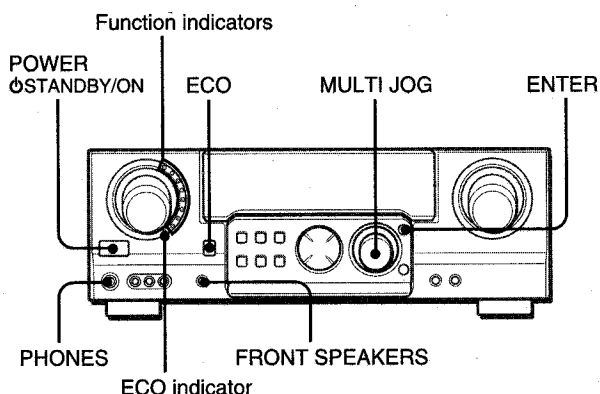

To turn the unit on

Press POWER \odot STANDBY/ON.

Operation is possible after four seconds. The VOL (volume) level or function name is displayed one after the other for the first four seconds.

The selected function indicator lights up in red.

To change the brightness level of the display

- 1 Press ECO repeatedly until "DIM MODE" is displayed.
- 2 Within 4 seconds, press ENTER.
- 3 Within 4 seconds, turn MULTI JOG to select the dimmer mode as below.

The mode will be automatically set after 4 seconds. It will also be set if ENTER is pressed within 4 seconds after step 3.

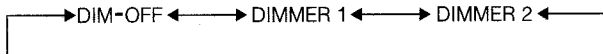

DIM-OFF: The normal display.

DIMMER 1: The illumination of the display is dimmer than usual.

DIMMER 2: The illumination of the display is dimmer than DIMMER 1. The function indicator turns off.

Using the headphones

Connect headphones to the PHONES jack with a standard stereo plug ($\varnothing 6.3$ mm, 1/4 inch). Be sure to set FRONT SPEAKERS to **OFF**. Otherwise sound is output from the speakers.

NOTE

When the headphones are plugged in:

- The Dolby Pro Logic or DSP system is automatically canceled.
- The Dolby Digital or DTS surround mode is changed to "2chSTEREO (2CH DOWNMIX)".

To turn the unit off, press POWER \odot STANDBY/ON.

POWER ECONOMIZING (ECO) MODE

Setting this unit to ECO mode reduces power consumption in standby mode.

Initial setting of ECO mode is ON.

- When the current time is set, the clock display disappears immediately.
- While the power is off, all the display lights turn off, and only the ECO indicator lights in red.

To cancel ECO mode

- 1 Press ECO to display "ECO MODE" while the unit is turned on.
- 2 Within 4 seconds, press ENTER.
- 3 Within 4 seconds, turn MULTI JOG to select "ECO OFF".
The mode will be automatically set after 4 seconds. It will also be set if ENTER is pressed within 4 seconds after step 3.

SETTING THE CLOCK

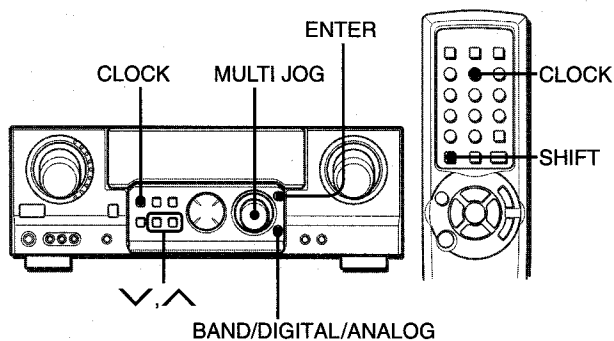

When the AC cord is connected for the first time, the clock on the display flashes.

Set the time as follows while the power is off.

1 Press ENTER.

The display becomes a little brighter.



2 Within 4 seconds, turn MULTI JOG to designate the hour and the minute.

The time advances by turning it to the right, and decreases by turning it to the left.

^/∨ on the main unit is also available. Press the button repeatedly. To change the time rapidly in 10-minute steps, hold it down.

3 Press ENTER.

The clock starts from 00 seconds.

NOTE

When the clock is set for the first time after purchase

Everything on the display will clear.

This is because the power economizing mode of the unit is activated, and is not a malfunction.

The power economizing mode can be canceled. See page 8 for details.

To correct the current time

Press POWER \odot STANDBY/ON to turn the unit off. Carry out steps 1 to 3 above.

To display the current time

Press CLOCK while pressing SHIFT on the remote control. The clock is displayed for 4 seconds.

When operating on the main unit, press CLOCK while the power is on and ENTER while the power is off (standby).

To switch to the 24-hour standard

Display the current time, and press BAND/DIGITAL/ANALOG on the unit within 4 seconds.

Repeat the same procedure to restore the 12-hour standard.

In the 12-hour standard, "AM 12:00" indicates midnight and "PM 12:00" indicates noon.

If the clock display flashes while the power is off

This is caused by a power interruption. The current time needs to be reset.

If power is interrupted for more than approximately 24 hours, all settings stored in memory after purchase need to be reset.

CUSTOM AUDIO ADJUSTMENT

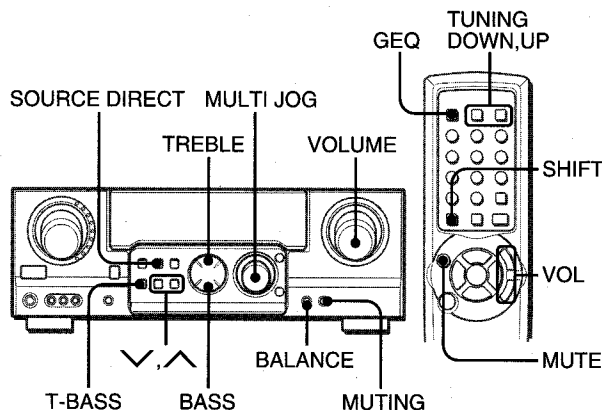

VOLUME CONTROL

Turn VOLUME on the unit, or press VOL on the remote control. The volume level is shown on the display for four seconds. It can be adjusted between 0 and MAX (50). It flashes when set over the level of 44.

The volume level remains memorized even after the power is turned off. However, if the power is turned off when the volume is set to 21 or higher, it is automatically set to 20 the next time the power is turned on.

To adjust the left/right balance of the front speakers

Press BALANCE to display "L/R 0dB". Then press \wedge/\vee repeatedly or turn MULTI JOG within four seconds.

Note that the front speaker balance for the Dolby and DTS surround is also changed.

To mute the sound temporarily

Press MUTING (MUTE) (-20 dB).

"MUTE ON" appears on the display for four seconds. While muting the sound, the selected function indicator flashes. Press MUTING again to restore the sound.

TONE CONTROL

You can adjust treble and bass sound.

- 1 Press TREBLE or BASS.
- 2 Within 4 seconds, press \vee/\wedge repeatedly or turn MULTI JOG to select the desired level.



Both the levels can be adjusted between -10 dB and +10 dB in 2 dB steps.

"TONE" is displayed while the TREBLE or BASS control is activated.

To adjust with the remote control

- 1 Press GEQ repeatedly while pressing SHIFT to display "TREBLE" or "BASS."
- 2 Press TUNING DOWN or UP while pressing SHIFT to adjust the level.

SUPER T-BASS SYSTEM

The T-BASS system enhances the realism of low-frequency sound.

Press T-BASS.

Each time it is pressed, the level changes. Select one of the three levels, or the off position to suit your preference.

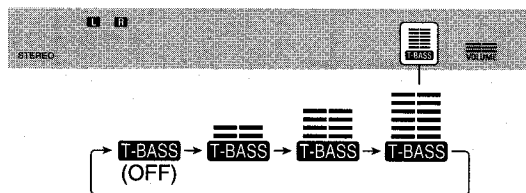

NOTE

Low-frequency sound may be distorted when the T-BASS system is used for a disc or tape in which low-frequency sound is originally emphasized. In this case, cancel the T-BASS system.

SOURCE DIRECT FUNCTION

You can cancel all the sound adjustments (except the volume), with their settings kept in memory, to listen to the original source sound.

Press SOURCE DIRECT.



"SOURCE DIRECT" runs through on the display and the indicator lights up.

Press it again to restore the sound adjustments.

NOTE

- While the source direct function is activated TAPE MONITOR and all the buttons to adjust the sound cannot be used.
- The source direct function is not available in digital mode.

SOUND ADJUSTMENT DURING RECORDING

The output volume and tone of the speakers or headphones may be freely varied without affecting the level of the recording.

DSP SURROUND

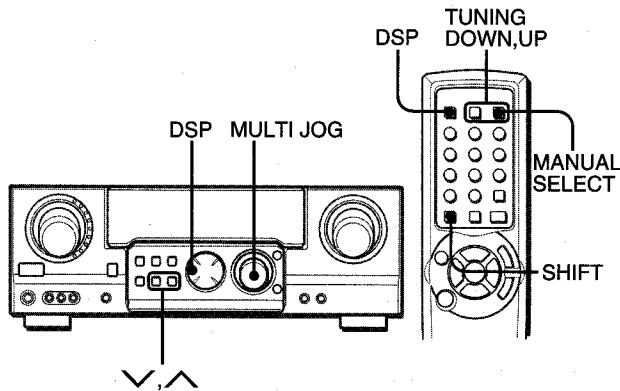

The DSP (Digital Signal Processor) surround circuits can recreate the effect of sounds reflected from walls or ceilings, to obtain the sound presence of real environments. The unit provides 5 DSP preset modes.

1 Press DSP.

2 Within 4 seconds, press repeatedly or turn MULTI JOG to select the desired DSP mode.

The "DSP" and "S" (surround speakers) indicators light up.

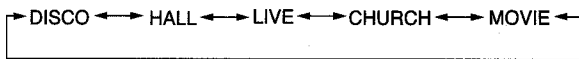

Selected mode

When the music source is monaural

The DSP system may not work effectively.

To cancel the selected mode

Press DSP to display the DSP mode name, and press the button again within 4 seconds. "DSP OFF" appears on the display.

To select with the remote control

1 Press DSP.

2 Within 4 seconds, press TUNING UP or DOWN repeatedly while pressing SHIFT until the desired DSP mode is displayed. 5 preset modes can be selected.

To adjust the volume of the surround speakers

Press MANUAL SELECT on the remote control three times to display "S 0dB" while the DSP system is turned on. Then press  repeatedly or turn MULTI JOG within four seconds.

NOTE

- The DSP surround system is automatically canceled and cannot be turned on:
 - When headphones are plugged in.
 - When the bit stream of Dolby Digital or DTS surround comes in the unit in DIGITAL mode.
 - When the SOURCE DIRECT function is activated.
- The DSP surround system is automatically canceled when the Dolby Pro Logic system is turned on, and vice versa.

SOUND

En

SELECTION OF AUDIO/VIDEO SOURCE

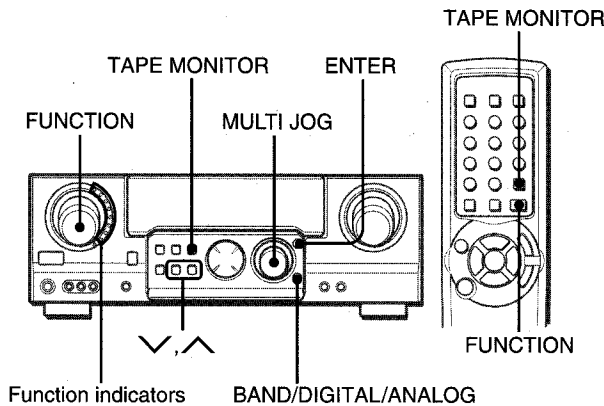

1 Select the program source.

Turn FUNCTION or press TAPE MONITOR. The selected function indicator lights in red.

To listen to or watch	The indicator in red
Tape	TAPE MONITOR
Radio	TUNER
Record	PHONO
Compact disc	CD
Television, etc.	AUX
Video	VIDEO 1/DVD/MD, VIDEO 2/LD/TV, VIDEO 3
LD or Cable TV	VIDEO 2/LD/TV
MD or DVD	VIDEO 1/DVD/MD

The function to be selected (except PHONO) depends on the equipment connected to the input terminals on the rear panel of the unit.

To select with the remote control

Press TAPE MONITOR or FUNCTION repeatedly.

NOTE

When using a turntable with a built-in equalizer amplifier, set the switch of the equalizer amplifier to off. See the instructions of the turntable for further information.

2 Start the selected program source.

3 Adjust the sound.

About the video source to the monitor or TV



Selected video source

V1: VIDEO 1, V2: VIDEO 2, V3: VIDEO 3

The selected video source is indicated on the display and the video signal is output through the MONITOR VIDEO OUT jack on the TV.

To select the video source

- 1 Turn FUNCTION to select PHONO, CD or AUX.
- 2 Press ENTER to display VIDEO 1.
- 3 Turn MULTI JOG to select VIDEO 2 or VIDEO 3.

To change a displayed name for the VIDEO 1 and VIDEO 2 function

When the VIDEO 1 function is selected, VIDEO 1 is displayed initially. It can be changed to DVD or MD.

Press BAND/DIGITAL/ANALOG while pressing ENTER, then release ENTER first.

The displayed name for the VIDEO 2 function can be changed to VIDEO 2, LD or TV; while the VIDEO 2 function is selected, press BAND/DIGITAL/ANALOG while pressing ENTER, then release ENTER first.

To select "ANALOG" or "DIGITAL" (Dolby Digital or DTS surround) mode of the VIDEO 1 or VIDEO 2 function

Press BAND/DIGITAL/ANALOG when the VIDEO 1 or VIDEO 2 function is selected. The selected mode "ANALOG" or "DIGITAL" appears on the display.

In DIGITAL mode: Equipment connected to the VIDEO 1 OPTICAL IN terminal is selected as a source for the VIDEO 1 function, and equipment connected to the VIDEO 2 COAXIAL IN terminal for the VIDEO 2 function.

In ANALOG mode: Equipment connected to the VIDEO 1/DVD/MD IN terminals is selected as a source for the VIDEO 1 function, and equipment connected to the VIDEO 2/LD/TV terminals for the VIDEO 2 function.

NOTE

"DIGITAL" mode changes to "ANALOG," when pressing TAPE MONITOR.

When the "OVER LEVEL" indicator lights up

The unit is equipped with the OVER LEVEL indicator. When input analog signals from the connected equipment are too high to accept, the indicator lights up. In this case, adjust the input level as mentioned below so that the indicator disappears.

To adjust the sound level of the connected source

The input sensitivity level of each function can be adjusted (except the TUNER, VIDEO 1 (DIGITAL) and VIDEO 2 (DIGITAL) functions).

When the sound level of the connected source is higher than that of the TUNER, adjust it as follows.

1 Select the function to be adjusted.

Turn FUNCTION or press TAPE MONITOR and play the source. Be sure to turn off the source direct function.

2 Press ∇ twice to lower the level.

To restore, press \wedge twice so that "0 dB" is displayed.



TO PLAY A DVD OR LD RECORDED IN DOLBY DIGITAL OR DTS SURROUND

This receiver is equipped with the Dolby Digital decoder and DTS decoder, and has the digital in (both OPTICAL and COAXIAL) terminals. When a DVD or LD player is connected to the digital in terminal of the receiver, you can enjoy theater-quality audio right in your home when playing discs recorded in Dolby Digital surround or DTS surround.

Before operation

- Check that TAPE MONITOR or SOURCE DIRECT is not activated.
- When connecting an LD player equipped with the AC-3 RF OUT terminal, use an RF demodulator unit. Also connect the analog AUDIO OUT terminals of the LD player to the receiver to play all the sources. For further information, refer to the instructions of the LD player.

- 1 Turn **FUNCTION** to select the **VIDEO 1 (VIDEO 2)** function and press **BAND/DIGITAL/ANALOG** repeatedly until **"DIGITAL"** is displayed.



The DVD (LD) player connected to the VIDEO 1 OPTICAL (VIDEO 2 COAXIAL) IN terminal is selected as a source.

- 2 Start playing the DVD (LD) recorded in Dolby Digital surround or DTS surround.

- The "DOLBY DIGITAL" indicator will light on the display when the bit stream of the Dolby Digital surround comes in the unit.

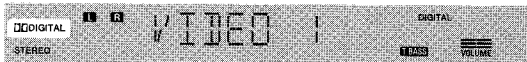

To select Dolby Digital surround mode according to your speakers, see "SELECTING DOLBY SURROUND" on page 16.

- The "dts" indicator will light on the display when the bit stream of the DTS surround comes in the unit.



To select DTS surround mode according to your speakers, see "SELECTING DTS SURROUND" on page 20.

NOTE

- While TAPE MONITOR or SOURCE DIRECT is activated, "DIGITAL" cannot be selected.
- When headphones are plugged in, Dolby Digital surround mode or DTS surround mode is automatically changed to "2chSTEREO" and the "STEREO" indicator lights on the display. Even if SURROUND is pressed while the headphones are plugged in, the mode cannot be changed.
- This unit supports input signals of the Dolby Digital surround bit stream, DTS surround bit stream and linear PCM whose sampling frequency is 32 kHz, 44.1 kHz and 48 kHz.
- When connecting some DVD players to the receiver through the digital in terminals, noise may be heard in the DVD operation: e.g. searching a disc, skipping a chapter.

RECORDING AN AUDIO SOURCE

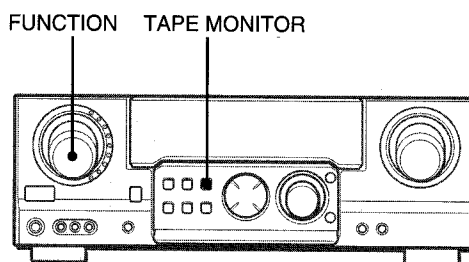

- 1 Select the program source to be recorded.
Turn **FUNCTION**.

- 2 Set the tape deck or MD recorder to recording mode.

- 3 Start the selected program source.

To monitor recorded sound during recording (when the connected tape deck is a three-head system)

Press **TAPE MONITOR**. "TAPE ON" appears on the display for four seconds, and then the source name selected in step 1 comes back on. To cancel the tape monitor, press it again so that "TAPE OFF" appears.

NOTE

- TAPE MONITOR is not available when the source direct function is activated.
- Any sound control system has no effect on recording (see page 10).
- Input sound through the digital in terminals cannot be recorded. When recording the sound from the DVD, CD, MD or LD player, connect the analog AUDIO OUT terminals of the player to the corresponding AUDIO IN terminals of the receiver. The sound will be recorded in 2 ch stereo.
- When recording audio sources by the MD recorder connected to the VIDEO 1/DVD/MD AUDIO OUT terminals, the selected video source (see page 12) should be V2 or V3. Recording cannot be done while the V1 (VIDEO 1) is selected and displayed on the window.
- Input sound from the tape deck connected to the TAPE MONITOR IN terminals cannot be recorded.

Selecting DTS digital mode

There are some audio CDs recorded in DTS surround. You can play DTS audio CDs in the same way as DVDs, but there may be a noise at the beginning part of the disc.

When playing DTS audio CDs, it is recommended to select "DTS" digital mode.

- 1 Select "ANALOG" mode.
- 2 Hold down **BAND/DIGITAL/ANALOG** until "DTS" appears on the display.

To restore auto "DIGITAL" mode, repeat the above so that "DIGITAL" appears on the display.

MANUAL TUNING

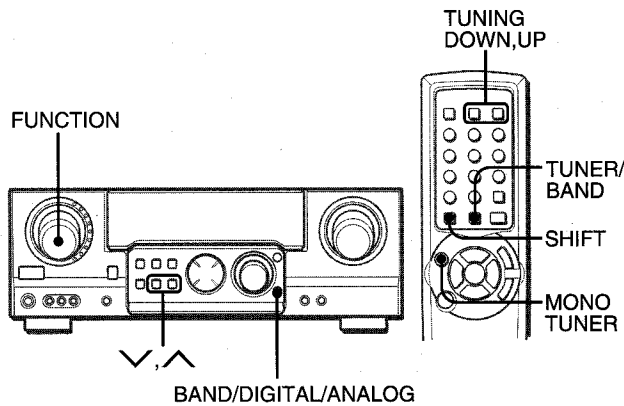

- 1 Turn **FUNCTION** to select the **TUNER** function, and press **BAND/DIGITAL/ANALOG** repeatedly to select the desired band.

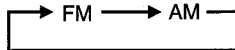

The display changes to frequency indications after indicating band and video source (V1, V2 or V3) for two seconds.

- 2 Press **▲/▼** to select a station.

Each time the button is pressed, the frequency changes. When a station is received, "TUNE" is displayed for two seconds. During FM stereo reception, ((Ⓜ)) is displayed.



When operating with the remote control

Press **TUNER/BAND** while pressing **SHIFT** in step 1, and **TUNING DOWN** or **UP** while pressing **SHIFT** in step 2.

To search for a station quickly (Auto Search)

Keep **▲/▼** pressed until the tuner starts searching for a station. After tuning in to a station, the search stops.

To stop the Auto Search manually, press **▲/▼**.

When operating with the remote control, keep **TUNING UP** or **DOWN** pressed while pressing **SHIFT**.

- The Auto Search may not stop at stations with very weak signals.

When an FM stereo broadcast contains noise

Press **MONO TUNER** while pressing **SHIFT** on the remote control so that "MONO" appears on the display.

Noise is reduced, although reception is monaural.



To restore stereo reception, repeat the above so that "STEREO" appears.

When the reception contains noise interference
Move the unit away from other electrical appliances, especially digital audio devices, or turn off the appliances that generate noise signals.

To change the AM tuning interval
The default setting of the AM tuning interval is 10 kHz/step. If you use this unit in an area where the frequency allocation system is 9 kHz/step, change the tuning interval. Hold down **BAND/DIGITAL/ANALOG** and press **POWER** **STANDBY/ON**. To reset the interval, repeat this procedure.

PRESETTING STATIONS

PRESET NUMBER TUNING

- 1 Select a band.
- 2 Turn MULTI JOG to select a preset number.

When operating with the remote control

Press TUNER/BAND while pressing SHIFT to select a band, then press the numbered buttons to select a preset number.

Example:

To select preset number 25, press 2 and 5.

To select preset number 7, press 7.

To clear a preset station

Select the preset number of the station to be cleared. Then, press ENTER, and press it again within four seconds.

The preset numbers of all other stations in the band with higher numbers are decreased by one.

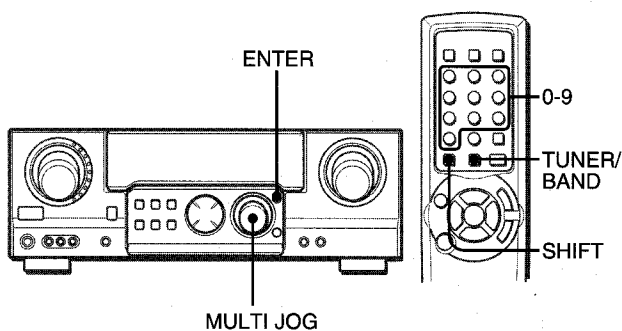

The unit can store a total of 32 preset stations. When a station is stored, a preset number is assigned to the station. Use the preset number to tune in to a preset station directly.

- 1 Tune in to a station to be preset.
- 2 Press ENTER to store the station.

A preset number assigned to the station, beginning from 1 in consecutive order for each band, appears in the display for two seconds.



- 3 Repeat steps 1 and 2.

No more stations will be stored and "FULL" appears if a total of 32 stations have already been stored for all the bands.

NOTE

When the AM tuning interval is changed, all preset stations are cleared. The preset stations have to be set again.

This unit is equipped with the Dolby Pro Logic decoder, Dolby Digital decoder and DTS decoder.

The unit and the center and surround speakers (standard) assure full-scale home theater sound. When playing back discs or video software that have been recorded in Dolby Pro Logic, Dolby Digital surround or DTS surround, astonishingly realistic sound surrounds the listener to create a new level of audio/visual entertainment.

Independent control of the five channels allows the listener to enjoy the same type of sound reproduction experienced in movie theaters. Voices are reproduced in the front and center sound field, while ambient sounds like cars and crowds are reproduced on all sides of the listener for an incredibly lifelike audio/video experience. Please read the following carefully to "tune" the system's output to match the characteristics of your listening space.

Check the following:

- Before enjoying Dolby surround sound or DTS surround sound, adjust the speaker sound levels to the proper balance (see page 17).
- Make sure the speakers are properly connected and positioned (see pages 5 and 6).
- Make sure the TV set and video unit are properly connected (see page 4).
- Make sure the disc and video tape, etc., support Dolby Pro Logic, Dolby Digital surround or DTS surround.

SELECTING DOLBY SURROUND

The optimal Dolby Digital surround and Dolby Pro Logic modes and settings depend on the type and placement of the speakers. Check the current type and placement of your speakers and select the recommended mode accordingly.

Recommended mode

[Dolby Digital Surround]

	Center speaker		
	Larger-size	Smaller-size	No speaker
Surround speaker (Rear speaker)	DOLBY D-WIDE	DOLBY D-NORMAL	PHANTOM
No surround speaker	3 STEREO-WIDE	3 STEREO-NORMAL	2chSTEREO

[Dolby Pro Logic]

	Center speaker		
	Larger-size	Smaller-size	No speaker
Surround speaker (Rear speaker)	PRO LOGIC-WIDE	PRO LOGIC-NORMAL	PHANTOM
No surround speaker	3 STEREO-WIDE	3 STEREO-NORMAL	-

PHANTOM mode: Select this mode when the center speaker is not connected. All center channel signals are redistributed to the left and right channel speakers.

3 STEREO mode: Select this mode when the surround speakers are not connected.

TO SELECT DOLBY SURROUND MODE

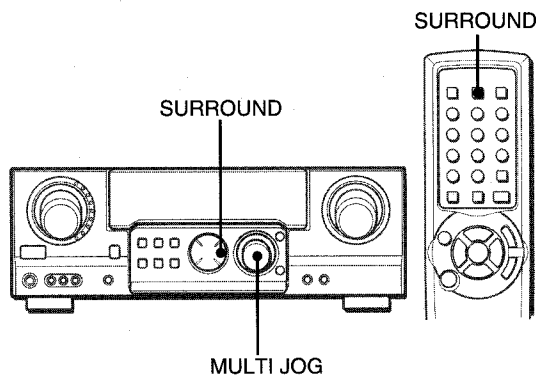

Preparations

- When selecting Dolby Digital surround mode, select the VIDEO 1 (DIGITAL) or VIDEO 2 (DIGITAL) function (see page 13) and play a disc recorded in Dolby Digital surround before selecting the mode.
- When selecting Dolby Pro Logic mode, select the function except VIDEO 1 (DIGITAL) and VIDEO 2 (DIGITAL).

1 Press SURROUND and turn MULTI JOG to select the appropriate mode.

The selected mode name appears on the display.

[Dolby Digital Surround]



To select 2chSTEREO mode, press SURROUND repeatedly until "2chSTEREO" appears.

NOTE

Select Dolby Digital surround mode while playing a source recorded in Dolby Digital surround.

[Dolby Pro Logic]



- 2 Press **SURROUND** again and hold it down until the center speaker mode to be selected appears. (Except 2chSTEREO and PHANTOM modes.)

"NORMAL" and "WIDE" appear one after the other.

When operating with the remote control

Press **SURROUND** repeatedly to select the mode, and hold it down to select the center speaker mode.

NOTE

- Depending on the sound source or listening condition, surround effect may not be obtained even when Dolby Digital surround or Dolby Pro Logic is selected.
- The full Dolby Digital surround or Dolby Pro Logic effect cannot be obtained when using software not recorded in Dolby Digital surround or Dolby Pro Logic system. In this case, use the DSP surround system instead (see page 11).
- When headphones are plugged in:
 - The Dolby Pro Logic system is automatically canceled.
 - The Dolby Digital surround mode is automatically changed to "2chSTEREO."
- While headphones are plugged in:
 - The Dolby Pro Logic cannot be turned on.
 - The Dolby Digital surround mode cannot be changed.

ADJUSTING SPEAKER LEVEL BALANCE

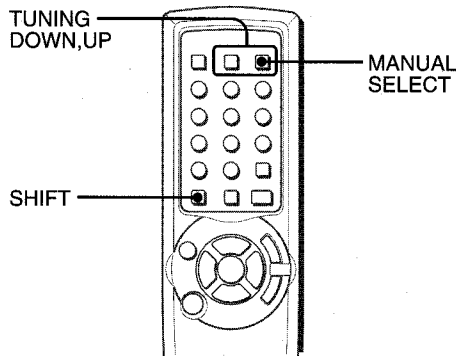

The unit is equipped with a built-in test signal generator called a noise sequencer for easy balance adjustment of all five channels. The sequencer outputs a noise signal that "travels" from channel to channel, enabling the simple adjustment of sound level to achieve the same apparent loudness, at your listening position, from each channel.

Preparation

- Before adjusting the speaker level balance, turn off the DSP surround system.
- Operate the unit while playing the source recorded in Dolby Digital surround or Dolby Pro Logic.

- 1 Select **Dolby Digital surround (except "2chSTEREO")** or **Dolby Pro Logic mode** according to the current type and placement of your speakers.

(See page 16.)

- 2 Press **MANUAL SELECT** on the remote control and hold it down for about two seconds until "L" of "L/R 0dB" starts to flash.



A noise signal is sent to each channel in turn as follows:

DOLBY D (PRO LOGIC) NORMAL or WIDE mode

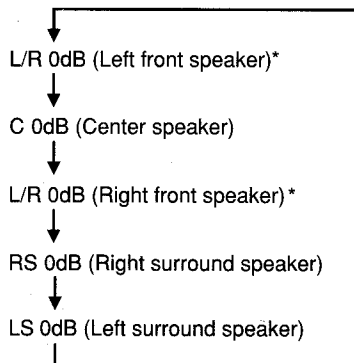

To be continued

DOLBY SURROUND AND DTS SURROUND

En

PHANTOM mode

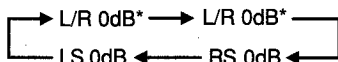

3 STEREO NORMAL or WIDE mode

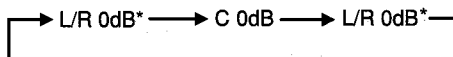

* "L" or "R" flashes to indicate one of the front speakers from which the noise signal is output.

3 Adjust the sound level of the center and surround speakers.

While "C," "RS" or "LS" flashes in the display, press **TUNING UP** or **DOWN** while pressing **SHIFT** on the remote control so that the sound level of the center or surround speakers matches that of the front speakers.

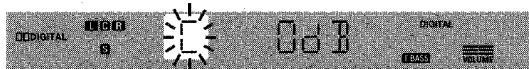

The balance of the front speakers can be adjusted as well while "L/R" is displayed.

NOTE

^/v on the main unit cannot be used.

4 Press **MANUAL SELECT** again to stop the noise signal.

NOTE

When adjusting the speaker level balance of Dolby Digital surround, that of Dolby Pro Logic is also changed and vice versa.

About the channels

The left and right speakers create the stereo effect.

The center speaker helps precise sound positioning over a broad sound field.

The rear-mounted surround speakers enhance the "depth" of the sound field.

To change the delay time of the surround speakers or center speaker in Dolby Digital surround or Dolby Pro Logic mode

While Dolby Digital surround (except "2chSTEREO") or Dolby Pro Logic is activated, press **MANUAL SELECT** on the remote control repeatedly so that "C 0mS" or "S 5mS" (S 20mS) is displayed. Then, within 4 seconds, press ^/v or turn **MULTI JOG**. The delay time changes as shown below.

[Center speaker]

Adjust the delay time so that lines (voice in a movie) are heard clearly and naturally.

The center speaker delay time is initially set to 0 ms (milliseconds). It can be adjusted between 0 and 5 ms in 1 ms step.

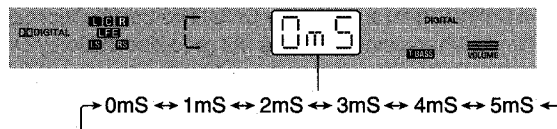

[Surround speakers]

Adjust the delay time to suite your preference.

Dolby Digital Surround

The speakers delay time is initially set to 5 ms. It can be adjusted between 0 and 15 ms in 5 ms steps.

Dolby Pro Logic

The speakers delay time is initially set to 20 ms. It can be adjusted between 15 and 30 ms in 5 ms steps.

NOTE

- When adjusting the delay time of the surround speakers or center speaker for Dolby Digital surround, that of Dolby Pro Logic is changed, and vice versa.
- When the surround speakers delay time of Dolby Digital surround is set to 0 ms (5 ms, 10 ms, or 15 ms), that of Dolby Pro Logic is set to 15 ms (20 ms, 25 ms or 30 ms), and vice versa.

To adjust the speaker level balance while listening to the source

The speaker level balance can be changed after adjusting it with the noise sequencer. The balance can be changed whenever Dolby Digital surround or Dolby Pro Logic is activated.

- 1 Play a disc or video software recorded in Dolby Pro Logic or Dolby Digital surround.
- 2 Press **MANUAL SELECT** on the remote control repeatedly so that "L/R," "C," "RS" or "LS" appears on the display.
- 3 Press ^/v or turn **MULTI JOG** while the speaker name to be adjusted is displayed.

ADJUSTING LFE AND DYNAMIC RANGE

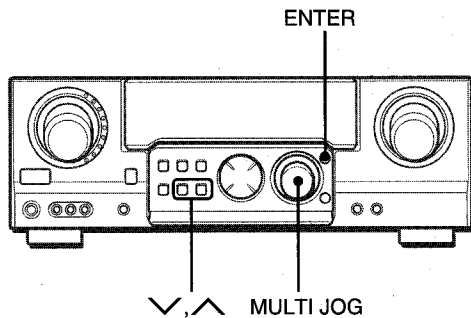

ADJUSTING LOW FREQUENCY SOUND EFFECT(LFE)

The disc recorded in Dolby Digital and DTS surround contains special signals called LFE to enhance low frequency sound effect. The LFE signals are recorded in some particular parts on the disc and output from the connected sub-woofer to reproduce astonishingly powerful low sound. The sound level of the LFE signals can be adjusted according to your speakers while Dolby Digital or DTS surround is activated.

Preparation

- When connecting a sub-woofer, select "SUBW ON" (see page 6).
- Play a disc recorded in Dolby Digital or DTS surround.

1 Press and hold it down until "LFE" is displayed.

2 Press repeatedly or turn MULTI JOG to adjust the LFE level.

The unit is initially set to 0 dB (maximum) and can be adjusted as shown below.



OFF ↔ -20dB ↔ -15dB ↔ -10dB ↔ -5dB ↔ 0dB

- When setting the LFE level to OFF, the "LFE" indicator goes off.
- When selecting "SUBW OFF", the LFE signals are redistributed to other speakers.

ADJUSTING DYNAMIC RANGE

Dynamic range of the Dolby Digital surround sound can be adjusted. The unit is initially set to "STD" (standard) mode.

1 While Dolby Digital surround is activated, press ENTER and hold it down until "MID NIGHT THEATER" runs through on the display.



2 Press or turn MULTI JOG to select "MAX," "STD" or "MIN".

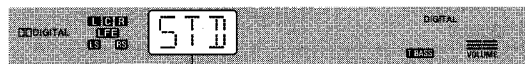

MIN ↔ STD ↔ MAX

[MIN]

You can enjoy the full dynamic range of sound like in the movie theater.

[STD]

Original position, when playing back in home, that is recommended by the software producers.

[MAX]

Select this mode when playing back at low volume. This is the mode used with the midnight setting.

DOLBY SURROUND AND DTS SURROUND

En

SELECTING DTS SURROUND

The optimal DTS surround modes and settings depend on the type and placement of the speakers. Check the current type and placement of your speakers and select the recommended mode accordingly.

Recommended mode

	Center speaker	No center speaker
Surround speaker (Rear speaker)	5.1ch	4 ch
No surround speaker	3 STEREO	2chSTEREO

4 ch mode: Select this mode when the center speaker is not connected. All center channel signals are redistributed to the left and right channel speakers.

3 STEREO mode: Select this mode when the surround speakers are not connected.

TO SELECT DTS SURROUND MODE

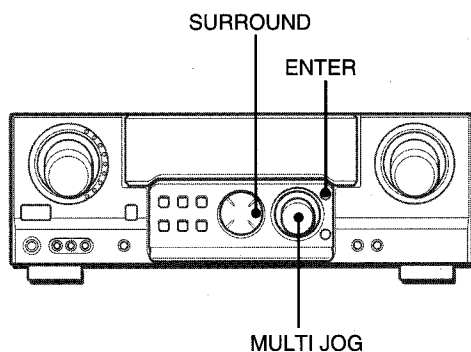

Preparation

When selecting DTS surround mode, select the DIGITAL function and play a disc recorded in DTS surround before selecting the mode.

1 Press SURROUND and turn MULTI JOG to select the appropriate mode.

The selected mode name appears on the display.

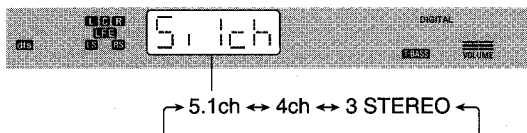

To select 2chSTEREO mode, press SURROUND repeatedly until "2chSTEREO" appears.

Before playing a disc, adjust the speaker level balance in Dolby Digital or Dolby Pro Logic mode as described in page 17.

To adjust the balance while listening to the source, see the right column in page 18 and follow the steps 2 and 3. The delay time of the center and surround speakers cannot be adjusted in DTS surround mode.

NOTE

- Depending on the sound source or listening condition, surround effect may not be obtained even when DTS surround is selected.
- The full DTS surround effect cannot be obtained when using software not recorded in DTS surround. In this case, use the DSP surround system instead (see page 11).
- When headphones are plugged in, DTS surround mode is automatically changed to "2chSTEREO."
- While headphones are plugged in, DTS surround mode cannot be changed.

TO LISTEN TO THE ORIGINAL DTS SOUND

When "dts" appears on the display, all the sound settings can be canceled.

1 While DTS surround is activated, press ENTER so that "BYPASSOFF" appears on the display.



2 Press ENTER again to display "BYPASS ON."



To restore the sound settings

Repeat steps 1 and 2 so that "BYPASSOFF" appears.

SETTING THE SLEEP TIMER

DOLBY SURROUND AND DTS SURROUND / TIMER

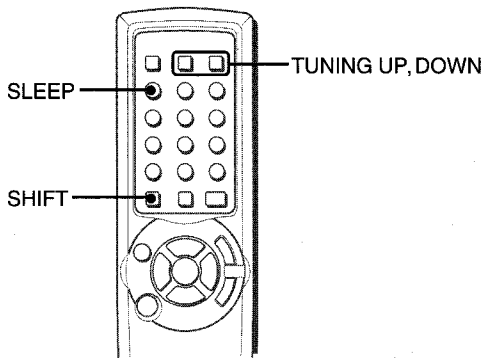

The receiver can be automatically turned off at a specified time.

Press SLEEP while pressing SHIFT on the remote control.



The unit will be turned off after about 60 minutes.

To specify the time until the power is turned off

Within 4 seconds after the above, press TUNING DOWN or UP repeatedly while pressing SHIFT.

You can change the time between 5 and 240 minutes in 5-minute steps.



Specified time

To check the time remaining until the power is turned off

Press SLEEP once while pressing SHIFT. The remaining time is displayed for four seconds.

To cancel the sleep timer

Press SLEEP twice while pressing SHIFT so that "SLEEPoFF" appears on the display.

En

SPECIFICATIONS

FM tuner section

Tuning range	87.5 MHz to 108 MHz
Usable sensitivity (IHF)	13.2 dBf
Antenna terminals	75 ohms (unbalanced)

AM tuner section

Tuning range	530 kHz to 1710 kHz (10 kHz step), 531 kHz to 1602 kHz (9 kHz step)
Usable sensitivity	350 μ V/m
Antenna	Loop antenna

Amplifier section

Power output	Front 80 W + 80 W (40Hz – 20kHz, T.H.D. less than 1%, 8 ohms) 105 W + 105 W (1 kHz, T.H.D. less than 10%, 8 ohms) Rear (Surround) 80 W + 80 W (40Hz – 20kHz, T.H.D. less than 1%, 8 ohms) 105 W + 105 W (1 kHz, T.H.D. less than 10%, 8ohms) Center 80 W (40Hz – 20kHz, T.H.D. less than 1%, 8 ohms) 105 W (1 kHz, T.H.D. less than 10%, 8ohms) 0.1 % (60 W, 1 kHz, 8 ohms, Front)
--------------	--

Total harmonic distortion Inputs

AUDIO IN	PHONO: 2.5 mV, adjustable (47 kohms) VIDEO 1/DVD/MD, VIDEO 2/LD/TV, VIDEO 3, CD: 300 mV, adjustable (47 kohms) TAPE MONITOR: 350 mV, adjustable (47 kohms) AUX: 300 mV, adjustable (47 kohms)
DIGITAL IN	COAXIAL (VIDEO 2): OPTICAL (VIDEO 1): accept linear PCM signals and bit stream of Dolby Digital and DTS surround (32 kHz, 44.1 kHz and 48 kHz) VIDEO IN: 1 Vp-p (75 ohms)

Outputs

AUDIO OUT (REC OUT): 300 mV (1 kohm)
VIDEO OUT (MONITOR): 1 Vp-p (75 ohms)
SUPER WOOFER: 1.5 V
FRONT SPEAKERS IMP: 8 Ω : accepts speakers of 8 ohms or more.
SURROUND SPEAKERS IMP: 8 Ω : accepts speakers of 8 ohms or more
CENTER SPEAKER IMP: 8 Ω : accepts speaker of 8 ohms or more. PHONES (stereo jack): accepts headphones of 32 ohms or more
-20 dB

Muting

General

Power requirements	120 V AC, 60 Hz
Power consumption	155 W
Power consumption in standby mode	ECO OFF: 28.5 W ECO ON: 1.1 W
Dimensions (W x H x D)	430 x 155 x 402 mm (17 x 6 ¹ / ₈ x 15 ⁷ / ₈ in.)
Weight	8.9 kg (19 lb 10 oz.)

Specifications and external appearance are subject to change without notice.

- Manufactured under license from Dolby Laboratories. "Dolby", "Pro Logic" and the double-D symbol are trademarks of Dolby Laboratories. Confidential Unpublished Works. ©1992-1997 Dolby Laboratories, Inc. All rights reserved.
- Manufactured under license from Digital Theater Systems, Inc. US Pat. No. 5,451,942 and other world-wide patents issued and pending. "DTS" and "DTS Digital Surround" are trademarks of Digital Theater Systems, Inc. ©1996 Digital Theater systems, Inc. All Rights Reserved.

CARE AND MAINTENANCE

Occasional care and maintenance of the unit is needed to optimize the performance of your unit.

To clean the cabinet

Use a soft dry cloth.

If the surfaces are extremely dirty, use a soft cloth lightly moistened with mild detergent solution. Do not use strong solvents, such as alcohol, benzene or thinner as these could damage the finish of the unit.

TROUBLESHOOTING GUIDE

If the unit fails to perform as described in these Operating Instructions, check the following guide.

GENERAL

There is no sound.

• Is "5.1ch IN" displayed in the display window?

Press TAPE MONITOR while pressing SHIFT on the remote control to cancel 5.1CH INPUT mode.

This unit does not have the 5.1CH INPUT terminals.

- Is the AC cord connected properly?
- Is there an incorrect connection? (→ page 4, 5)
- There may be a short circuit in the speaker terminals.
→ Disconnect the AC cord, then correct the speaker connections.
- Was an incorrect function button pressed?
- Was TAPE MONITOR pressed?
- Is FRONT SPEAKERS set correctly? (→ page 8)

Sound is emitted from one speaker only.

- Is BALANCE set appropriately?
- Is the other speaker disconnected?

Sound is heard at a very low volume.

- Has MUTING been pressed?

An erroneous display or a malfunction occurs.

→ Reset the unit as stated below.

TUNER SECTION

There is constant, wave-like static.

- Is the antenna connected properly? (→ page 6)
- Is the FM signal weak?
→ Connect an outdoor antenna.

The reception contains noise interference or the sound is distorted.

- Is the system picking up external noise or multipath distortion?
→ Change the orientation of the antenna.
→ Move the unit away from other electrical appliances.

To reset

If an unusual condition in the display window or malfunction occurs, reset the unit as follows.

- 1 Press POWER ϕ STANDBY/ON to turn off the power.
- 2 Press POWER ϕ STANDBY/ON while pressing ENTER.

Everything stored in memory after purchase is canceled.

If the power cannot be turned off in step 1 because of a malfunction, reset by disconnecting the AC cord and carry out step 2.

PARTS INDEX

Instructions about each part on the unit or remote control are indicated on the pages listed below.

(in alphabetical order)

AUDIO	7
BALANCE	10
BAND/DIGITAL/ANALOG	9, 12-15
BASS	10
CLOCK	9
DISC SKIP (CD)	7
DSP	11
DVD PAUSE	7
ECO	8
ENTER	7-9, 12, 15, 19, 20, 23
FRONT SPEAKERS	8
FUNCTION	7, 12-14
GEQ	10
MANUAL SELECT (TEST)	6, 11, 17, 18
MENU	7
MONO TUNER	14
MULTI JOG	6, 8-12, 15, 16, 18-20
MUTING (MUTE)	10
PHONES	8
POWER ϕ STANDBY/ON	8, 9, 14, 23
RETURN	7
SHIFT	7, 9-11, 14, 15, 18, 21
SLEEP	21
SOURCE DIRECT	10
SURROUND	16, 17, 20
TAPE MONITOR	12, 13
T-BASS	10
TITLE	7
TREBLE	10
TUNER/BAND	14, 15
TUNING DOWN(✓)	6, 9-12, 14, 18, 19, 21
TUNING UP(∧)	6, 9-12, 14, 18, 19, 21
VOLUME	10

NOTE

This equipment has been tested and found to comply with the limits for a Class B digital device, pursuant to Part 15 of the FCC Rules. These limits are designed to provide reasonable protection against harmful interference in a residential installation.

This equipment generates, uses, and can radiate radio frequency energy and, if not installed and used in accordance with the instructions, may cause harmful interference to radio communications. However, there is no guarantee that interference will not occur in a particular installation. If this equipment does cause harmful interference to radio or television reception, which can be determined by turning the equipment off and on, the user is encouraged to try to correct the interference by one or more of the following measures:

- Reorient or relocate the receiving antenna.
- Increase the separation between the equipment and receiver.
- Connect the equipment into an outlet on circuit different from that to which the receiver is connected.
- Consult the dealer or an experienced radio/TV technician for help.

CAUTION

Modifications or adjustments to this product, which are not expressly approved by the manufacturer, may void the user's right or authority to operate this product.

AIWA CO.,LTD.



<http://www.aiwa.co.jp>

For assistance and information **call toll free 1-800-BUY-AIWA** (United States and Puerto Rico)